

**FT-101Z/ FT-107/ FT-707/ FT-901,902 (later version)
DISPLAY COUNTER UNIT (PB-2086A)**

**Custom Integrated Circuit (MSM9520RS)
Replacement Module**

Assembly and Installation Manual (v1.3e)

STEP-BY-STEP PROCEDURES

This manual describes how to assemble, install and make adjustments of the MSM9520RS replacement module using YAESU FT-101Z as the target transceiver. Most of the procedure described here can be directly applicable to other YAESU transceiver models: FT-107, FT-707 and FT-901,902 (later version only) as long as the MSM9520RS is used in their DISPLAY COUNTER UNIT (PB-2086A). Please refer to the last section of this manual for the differences among models.

(Step 1) Remove DISPLAY COUNTER UNIT (PB-2086A) from transceiver.

- PB-2086A is the printed circuit board mounted on the top of VFO box.
 - Detach all the connectors connected to the board. (3 connectors) Pull off the 3-pin connector connecting to the 5V regulator IC on the back. Disconnect the RCA input plug from the PRE-MIX UNIT.
 - Detach the black ground wire connection by loosening one of mounting screws of the PRE-MIX UNIT.
 - No unsoldering is needed at this point.
 - Make sure not to lose any of washers and screws. Pay special attention to the plastic screws used for the 2 of front side mounting screws of the board and isolating washer located under the board.
-

(Step 2) Modify DISPLAY COUNTER UNIT (PB-2086A).

This modification is necessary to increase the input signal amplitude to the counter so that a general-purpose microcontroller chip can be used in the place of a dedicated frequency counter chip.

- Remove the nonfunctional MSM9520RS by unsoldering 40 pins with unsoldering wires (SOLDER-WICK) or a vacuum unsoldering gun. Then make necessary modifications of the board described below:
 - 1) Replace X01 6.5536MHz quartz crystal with 20.000MHz quartz crystal.
 - 2) Replace C25 47pF (Other value may have been used.) with 22pF.
 - 3) Replace R16 100 k Ω with 2.2 k Ω .
 - 4) Replace R11 220 Ω with 33 Ω .
 - 5) Replace R10 220 Ω with 390 Ω .
 - 6) Replace Q03 2SC1674L with 2SC3605.

The pin ordering of 2SC3605 is different from 2SC1674L! Refer to Fig. 3 for the pin

ordering.

7) Remove D05 1S1555, D09 1S1555.

- If the cathode marking of D01 1S1555 and D02 1S1555 happens to be “white”, these diodes need to be replaced. (Diodes are included in this kit.) Refer to the troubleshooting section [2) Miscounting at Higher Band] of this manual.
- Please refer to Fig. 1 and Fig. 2 for the locations of the modification on the schematic diagram and the picture of the board.

6) Replace Q03 2SC1674L with 2SC3605. (Attention: BEC Pin Ordering!)

5) Replace R10 220 Ω with 390 Ω.

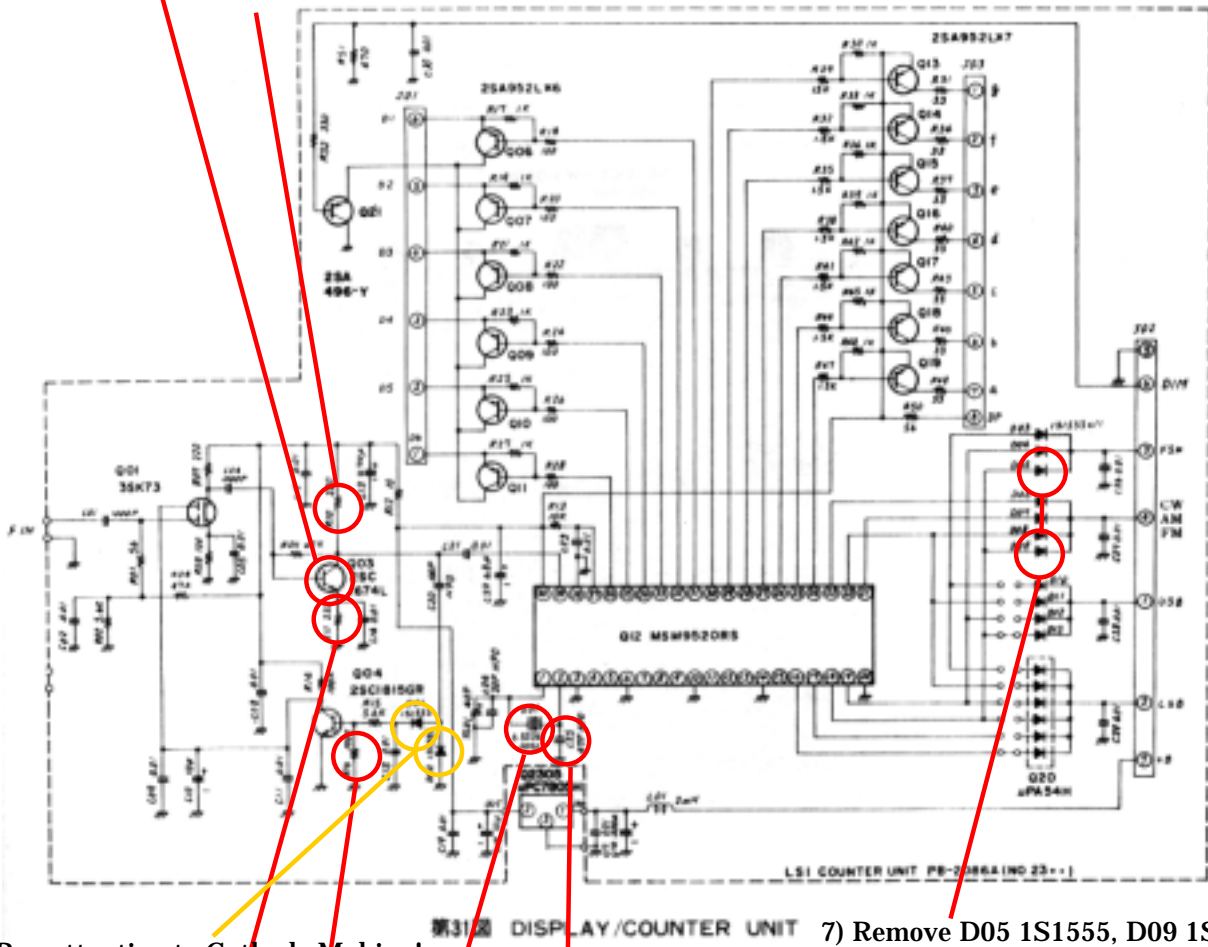

Pay attention to Cathode Making!

7) Remove D05 1S1555, D09 1S1555.

2) Replace C25 47pF (Other value may have been used.) with 22pF.

1) Replace X01 6.5536MHz quartz crystal with 20.000MHz quartz crystal.

3) Replace R16 100 kΩ with 2.2 kΩ.

4) Replace R11 220 Ω with 33 Ω.

Fig. 1 DISPLAY/COUNTER UNIT Modifications

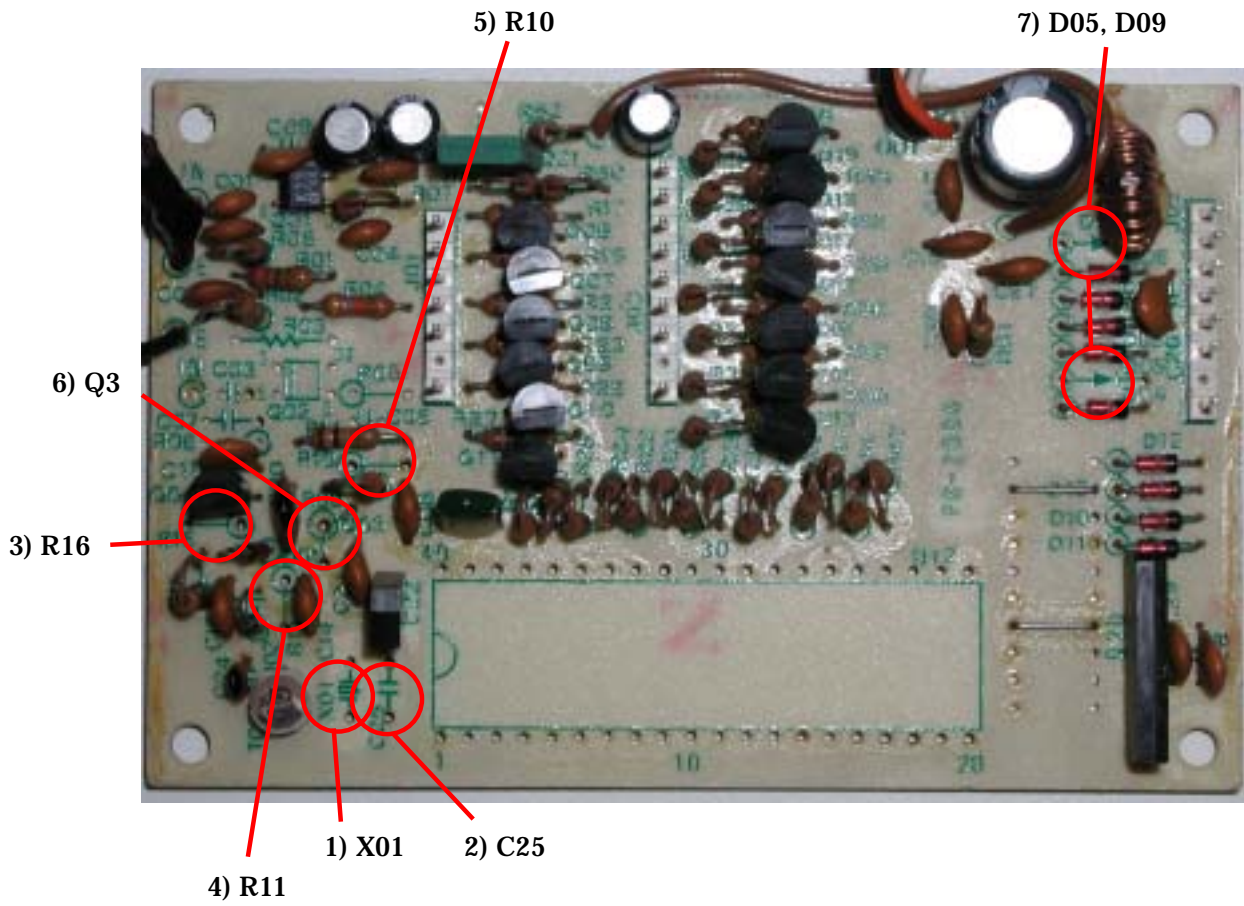

Fig. 2 Location of the Parts to be Replaced/ Removed

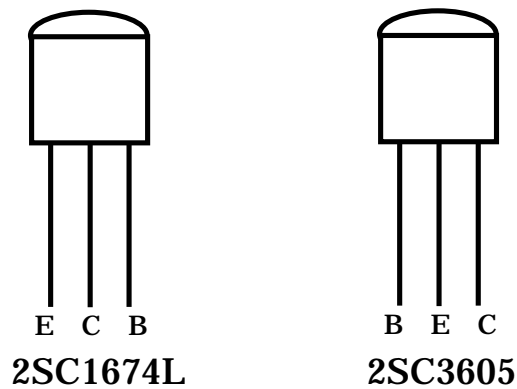

Fig. 3 2SC1674L and 2SC3605 Pin Ordering

Note:

- After unsoldering parts, or replacing parts, clean thoroughly the surface of the foil/solder side of the board with cotton buds damped with solvent.

(Step 3) Assemble the conversion board, which connects the 28 pins of PIC 16F873 microcontroller to the 40 pins of the MSM9520RS counter chip.

- Spend a while to determine the “sides” (TOP or BOTTOM) of the conversion board and the location of the #1 pin for the integrated circuit referring to Fig. 4.

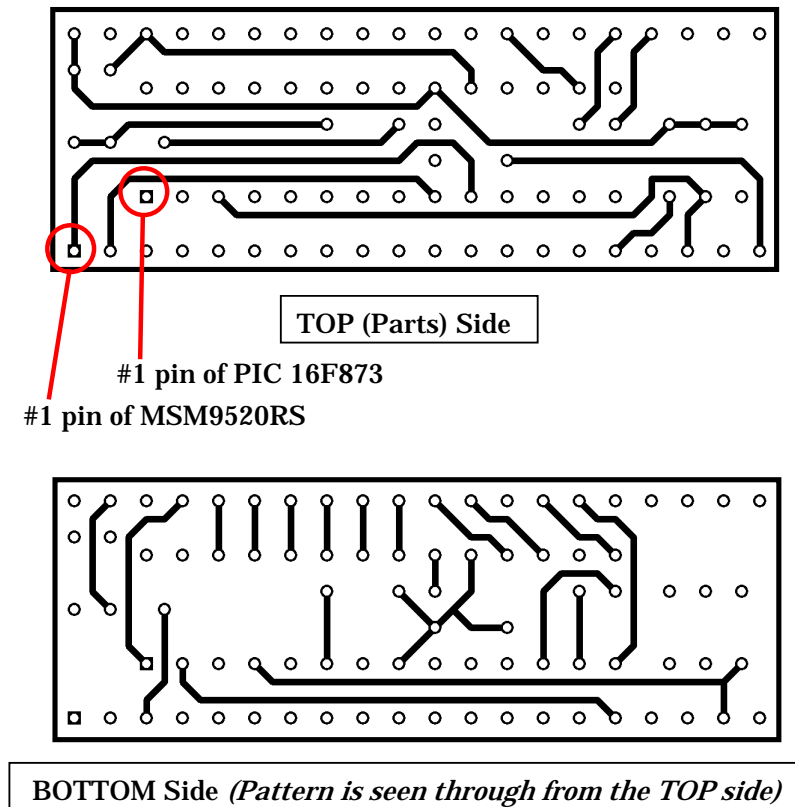

Fig. 4 Patterns of the Conversion Board for each Side

- Assemble and solder the following parts to the TOP side of the board.
 - 1) Bypass capacitor 0.1 μ F (1 of each) for PIC 16F873.
 - 2) Pull-up resistors 10k Ω (3 of each) for the mode select logic.

- 3) Biasing resistors $39\text{k}\Omega$ (2 of each) for the input circuit of the counter. (PIC 16F873)
- 4) 28 pin DIP socket for PIC 16F873. (Use 2 of 14-pin DIP socket.)

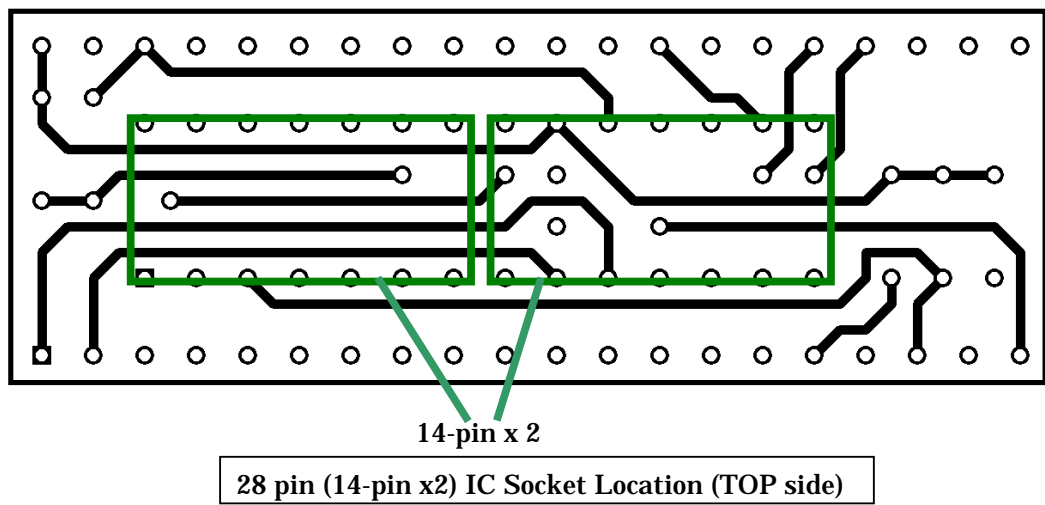
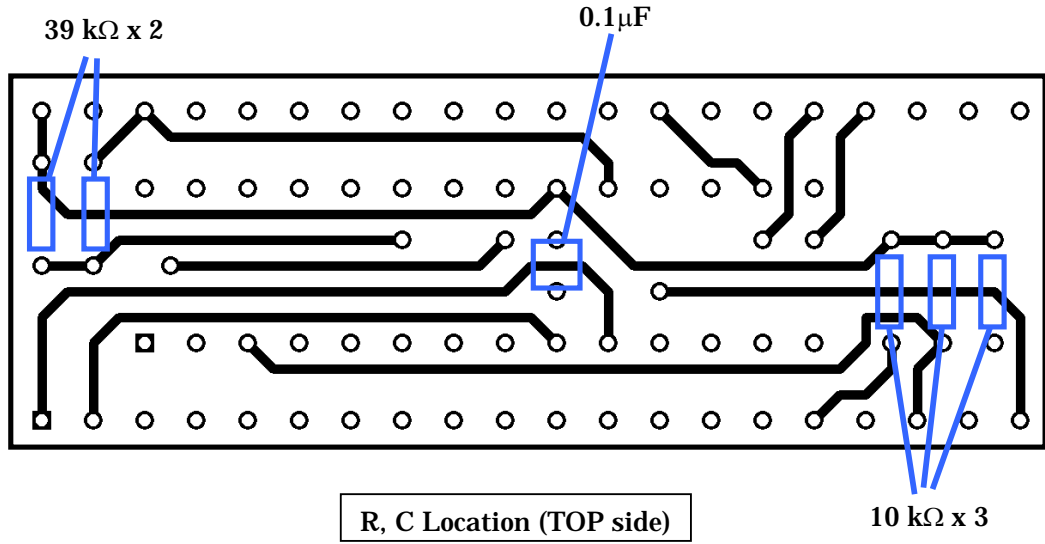

Fig. 5 TOP Side Assembly

Note:

- ◆ The 0.1 μ F bypass capacitor needs to be bended to fit under the socket.
- ◆ Use thin, pointed soldering iron to work with thin patterns and pads.
- ◆ The pads (rounded soldering patterns for parts leads) of the board are somewhat smaller to route one connecting line between 1/10 inch of DIP IC pins. Since holes of the boards are all plated conducting holes, it is advisable that the leads of parts are cut immediately at the soldering surface of the board, not bend along with the pattern, then solder the lead by “pouring” small amount of high quality solder.

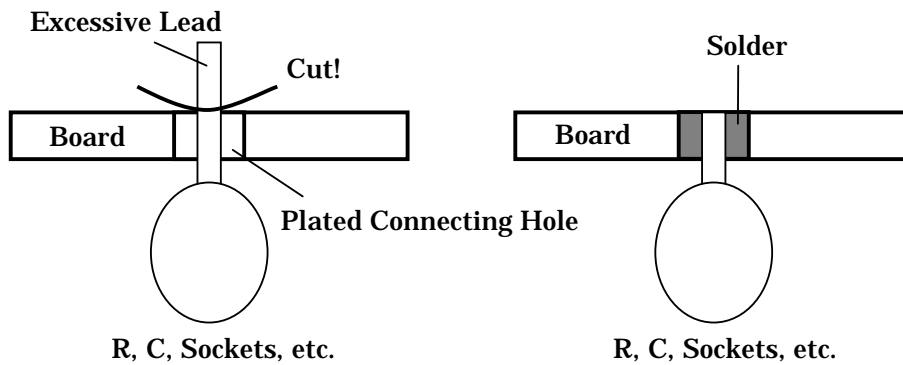

Fig. 6 Soldering of Plated Connecting Hole

- On the BOTTOM side, 40-pin DIP pin-header is placed and soldered.

Note:

- ◆ Before installing the pin-header and soldering 40 pins of it, make sure there is no “solder bridges” or short circuits on the board, by using a magnifying glass, etc. It is a good idea to use an Ohmmeter to make sure there is no low resistance, short path between adjacent pins of the PIC 16F873 sockets. Once the pin-header is installed, it is almost impossible to unsolder it from the plated connecting hole even a short circuit is found!
- ◆ The pin-header has a couple of reinforcing bars and it may interfere the excessive pins from the DIP sockets. Make sure to cut the excessive pins around the bar. (It is still advisable to cut all the leads short as described before.)

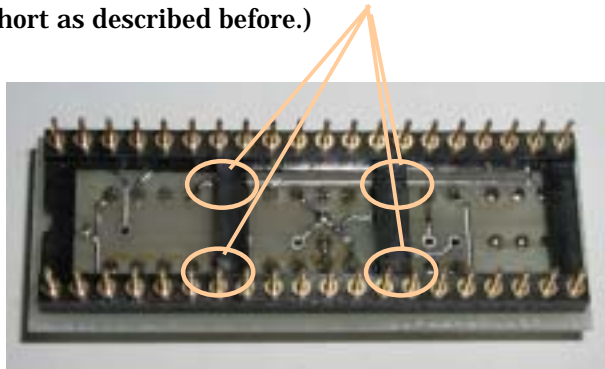

Fig. 7 BOTTOM Side

(Step 4) Install the conversion board on the DISPLAY COUNTER UNIT and solder pin-header pins. Inset the microcontroller chip, PIC 16F873 making sure to match the #1 pin. (Refer to Fig. 4 for the location of the #1 pin)



Fig. 8 Completed COUNTER DISPLAY UNIT (w/o PIC16F873)

(Step 5) Reinstall the DISPLAY COUNTER UNIT in FT-101Z, by following the reverse order of Step 1 and restore all the connections.

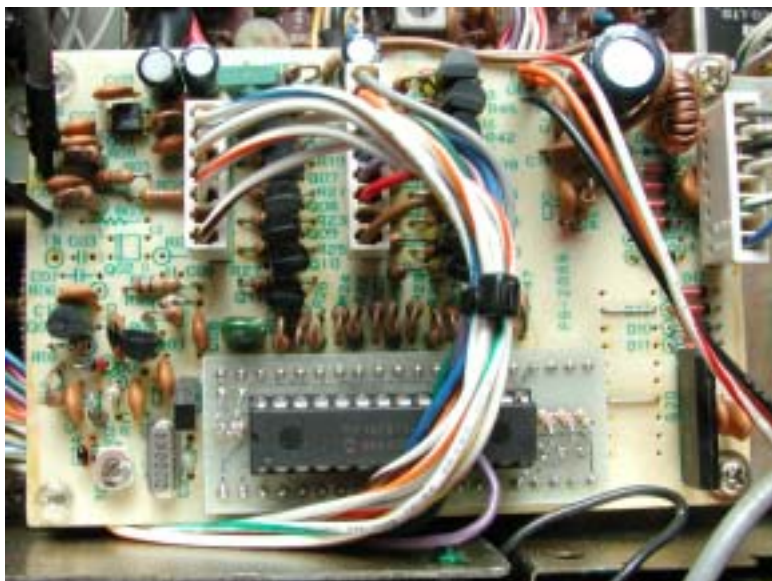

Fig. 9 Reinstalled COUNTER DISPLAY UNIT (w/ PIC16F873)

(Step 6 - Adjustment) Receive and tune to a known frequency, (e.g. WWV at 10.0000MHz), carefully adjust the dial to zero-beat note, and then adjust TC01 so that the display shows the known frequency exactly. USB or LSB mode should be used for this adjustment. Connecting a frequency counter input to one of the crystal terminals may disturb the oscillation, therefore not recommended.



Fig. 10 Revived FT-101Z

TROUBLE SHOOTING

1) Frequency adjustment cannot be achieved: displayed frequency is slightly higher than true frequency.

Due to the variation of crystals, capacitance tolerances, etc., it is sometimes impossible to adjust the PIC 16F873 clock frequency (= the frequency standard for the frequency measurement) to 20.000MHz by just adjusting TC01. Often encountered difficulty is that TC01 can only get to a frequency slightly lower than 20.000MHz, it results slightly (1 – 2 kHz) higher frequency indication on the display. For this case, remove C24 20pF from the DISPLAY COUNTER UNIT. This should correct the situation.

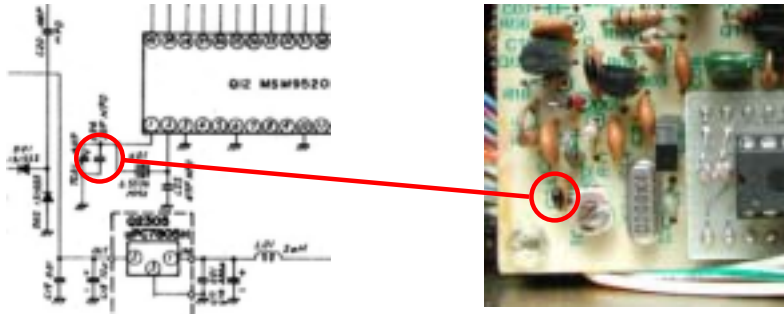

Fig. 11 Location of C24 20pF

2) Frequency display is unstable at higher bands. (20m/ 15m or higher) Or it does not count at all at higher bands. (A 90MHz offset frequency is displayed.)

It was found, at several initial users of this replacement module in Japan, that “wrong” diodes were mistakenly used in the place of the AGC detect diodes, D01 1S1555 and D02 1S1555 in the preamplifier of the DISPLAY COUNTER UNIT. (PB-2086A) Silicon detector diodes, 1S1555s should have been used for D01 and D02, but it is apparent that some sort of slow responding diodes for signal switching (look like MA190) were sometimes mistakenly used.

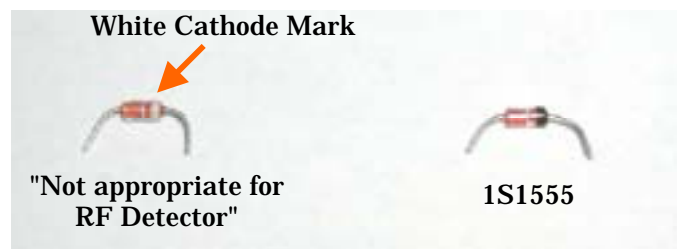

Fig. 12 Do not be fooled with diode

1S1555 type diodes have “black” cathode marking whereas the wrong diodes have “white” cathode marking.

When “white” marking diodes are used in the counter AGC detect circuit, (D01, D02) the circuit does not work as a detector, rather becomes a “heavy” loading to the output node of the preamplifier: The preamplifier cannot generate enough signal at higher frequency. The reason MSM9520RS used to work at this situation seems that it only required small signal amplitude to work. (to count)

When frequency counting is unstable at higher bands, measure the AGC voltage. (The Collector voltage of Q04 2SC1815 or G2 voltage of Q01 3SK73) If the voltage is almost constant over bands and close to the 5V supply, (If an analog circuit tester with coil meter is used, the measured value can be lower: 5V range of a 10k Ω /V class instrument may measure the voltage as low as 1.6V.) it is possible that D01 and D02 are broken, or wrong diodes are used. The AGC voltage should be less than 2V if the frequency band is set between 160(1.9MHz) to 20(14MHz), and it increases to almost 5V at 10(28MHz).

Replacing the wrong diodes with known to be good 1S1555s, or most of high speed switching diodes should solve the problem. 2 of 1S1588s from TOSHIBA are included in the kit in case D01 and D02 have the problem. Diodes removed from the diode matrix part of the board, D05 and D09 are supposed to be 1S1555 but when you see white marking diodes in the place of D01 and D02, all diodes on the board are the probably the same type, and therefore, using D05 and D09 for D01 and D02 is not recommended.

3) A specific digit of the display does not light, some segment of the entire digit keep lighting and numeric figure cannot be read, etc...

It is highly possible that a solder bridge(s) are formed while the conversion board is assembled and soldered. Turn off the transceiver, pull out the PIC 16F873, and then check the resistance value between each pins of PIC 28-pin socket and the chassis ground. Measured resistance should be greater than several hundreds Ohms. (Except 8 and 19 pins: They are VSS pins.) If it is a few Ohm, or even 0 Ohm, there is a dead short!

Remove the conversion board again from the DISPLAY COUNTER UNIT, and then carefully check the connection. It is highly advisable that you do this check before installing the 40-pin pin-header.

OTHER MODELS

1. FT-107

An additional front-end (3SK73) circuitry is added in the early version of this model so that it can switch the counter input to the dedicated local oscillator for the standard frequency broadcast reception. (5MHz WWV etc.) The later version does not have this addition. The same printed circuit board as FT-101Z (PB-2086A) is used but additional components are loaded on the board. The display brightness control, "DIM" is not implemented so the LED driver circuit is slightly simplified.

Though there are some differences, the internal frequency relationship, frequency offset calculations are exactly the same as FT-101Z. The exact same modification can be applicable to FT-107 and the same PIC microcontroller software/ binaries can be used. Modifications to PB-2086A can be performed according to Fig.2, but care needs to be taken: as additional components on the FT-107 circuit boards may be confusing.

2. FT-707

Unlike FT-101Z, the display brightness control, "DIM" is not implemented so the LED driver circuit is slightly simplified in FT-707. The internal frequency relationship, frequency offset calculations are exactly the same as FT-101Z. The same printed circuit board, PB-2086A is used as well. The exact same modification can be applicable to FT-707 and the same PIC microcontroller software/ binaries can be used.

3. FT-901,902 (later version only)

FT-901,902 was the "flagship" model from YAESU at that time therefore this model was produced long time and several slightly different versions exist. The FT-901,902 version that can benefit by the replacement module is its later version, which used PB-2086A DISPLAY COUNTER UNIT utilizing MSM9520RS. It can be recognized from its front panel: The later version has display brightness control, "DIM" on the left side of the frequency display whereas it was "CAL" in the earlier version. Please make sure your FT-901, 902 is the later version by checking the internal of your transceiver and its manual.

Modifying PB-2086A and installing the module can be exactly the same as for the case of FT-101Z.

Parts List

		Quantity
1	Microcontroller Chip: PIC 16F873 (programmed)	1
2	Printed Circuit Board for 28pin to 40 pin conversion (Double sided, through-hole, solder plated)	1
3	14 pin DIP Socket (2 used as 28 pin)	2
4	40 pin DIP Pin-Header	1
5	NPN Transistor: 2SC3605	1
6	1/6W, Carbon Film Resister: 39k Ω	2
	1/6W, Carbon Film Resister: 10k Ω	3
	1/6W, Carbon Film Resister: 2.2k Ω	1
	1/6W, Carbon Film Resister: 390 Ω	1
	1/6W, Carbon Film Resister: 33 Ω	1
7	Ceramic Capacitor: 22pF	1
8	Multilayer Ceramic Capacitor: 0.1 μ F	1
9	Quartz Crystal Unit: 20.000 MHz	1
10	High Speed Silicon Switching Diode: 1S1588 *	2

* In case D01 and D02 are happen to be "wrong" diodes.

CONTACTS

Teruhiko Hayashi (JA2SVZ) e-mail: thayashi@ta2.so-net.ne.jp